



INTRODUCTION TO VISION SENSORS

The Case for Automation with Machine Vision

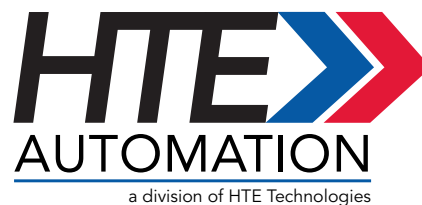
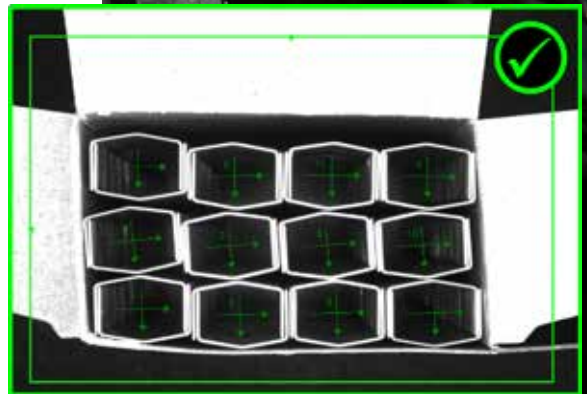
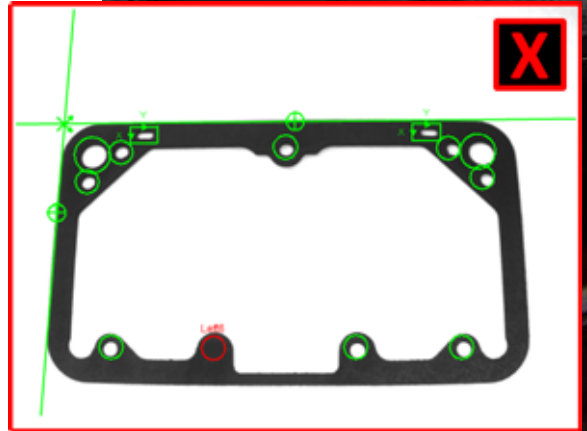
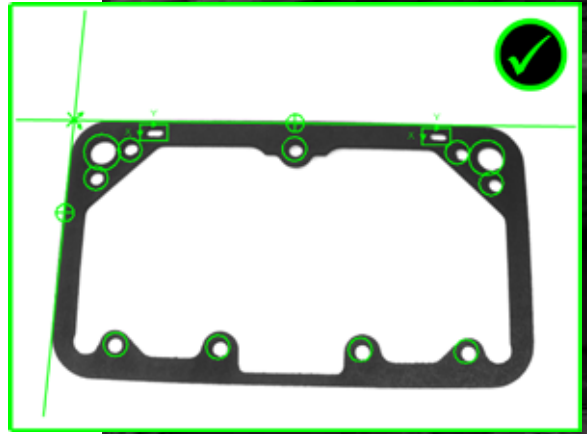

TABLE OF CONTENTS

Types of sensors.....	3
Vision sensors: a class apart	4
Vision sensors vs. vision systems	5
Vision sensor components.....	6
Solving applications with visions sensors	7
Vision tools.....	8
Choosing a vision sensor solution.....	9
Conclusion.....	9
The Cognex difference	9



INTRODUCTION TO VISION SENSORS

THE CASE FOR AUTOMATION WITH MACHINE VISION



Of the billions of products manufactured and inspected each day, few could be made without some level of industrial automation. Modern manufacturing demands high quality control standards. Manual inspection is slow, prone to error, and impeded by product size, space constraints, lighting conditions, and fast production line speeds. Automated inspection, by contrast, maximizes throughput, increases quality, and lowers manufacturing costs.

Most manufacturers use automated machinery like sensors because they are well-suited for repetitive inspection tasks. Sensors are faster, more objective, and work continuously. They can inspect hundreds, or even thousands, of parts per minute, providing more consistent and reliable inspection results.

But all sensors are not created equal. Low-cost photoelectric sensors can perform only a limited number of simple tasks, such as position verification and basic counting. They cannot distinguish between patterns or colors. And with their rigid mounting setup, they cannot handle misalignment or variability common in most work cells. Vision sensors offer greater flexibility, perform multiple inspection types within a single image, and generate additional rich data for quality and process improvement.

This guide provides an introduction to vision sensors and their common applications in factory automation. It is designed to help manufacturers determine whether vision sensors are right for them, and if so, to help them identify their needs.

TYPES OF SENSORS

There are a number of ways to extract data from a production line. In factory automation, sensors are used in work cells to gather data for inspection or to trigger other devices. These sensors fall into multiple categories; photoelectric, fiber optic, proximity, ultrasonic, and vision are the most common.

All factory automation sensors are fast, with multiple readings per second required for most applications. Data output is typically binary, delivered as a “yes/no,” “present/absent,” or “pass/fail” result. In some cases, sensors provide simple measurement outputs, though they are not designed for precision and accuracy. Most sensors typically support several communications protocols in order to communicate with upstream and downstream equipment and notify systems whether a part is present or passes inspection.

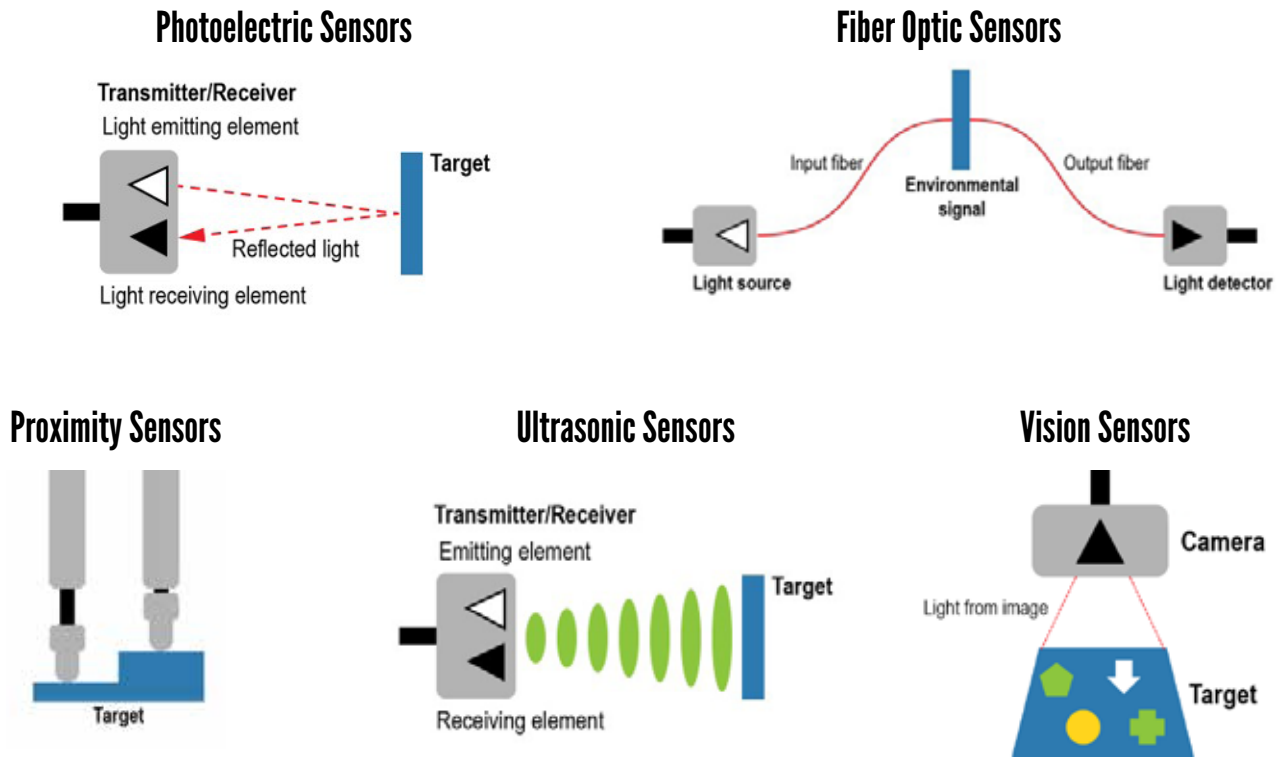

Figure 1: Sensors fall into multiple categories and can act complementarily.

In some cases, different types of sensors act as complementary technologies. Photoelectric sensors may be used in conjunction with vision sensors to communicate whether a part is on its way in order to trigger the camera in a machine vision system. Consider a fill-level inspection system at a brewery. Each bottle passes through an inspection sensor, which triggers a vision system to flash a strobe light and take a picture of the bottle. After acquiring the image and storing it in memory, vision software processes and analyzes it and issues a pass/fail response based on the fill level. If the system detects an improperly-filled bottle—a fail—it signals a diverter to reject the bottle. An operator can view rejected bottles and ongoing process statistics on a display.

VISION SENSORS: A CLASS APART

Vision sensors exhibit several characteristics which make them especially effective for factory automation. Not to be confused with the digital sensors inside a camera, vision sensors are a category of machine vision system designed to perform simple presence/absence inspections and deliver pass/fail results in unstructured environments. Vision sensors combine a camera's ability to take pictures with the processing power of a computer to make decisions about the position, quality, and completeness of a manufactured part or product. Vision sensors include a library of software tools that perform different types of inspections, even performing multiple types of inspections and delivering multiple pass/fail results from a single acquired image. Critically, and unlike other classes of sensors, vision sensors can handle multiple inspection points per target. Vision sensors can also detect their targets by pattern, feature, and color. They can detect specific parts within a very wide region of interest, and can do so dynamically as the part moves along the line.

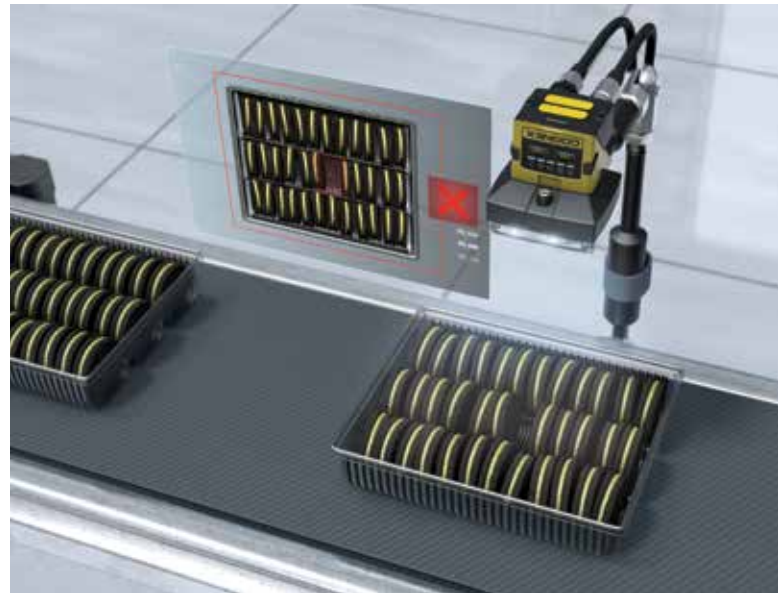

Figure 2. Vision sensors perform simple error-proofing applications, such as presence/absence and pass/fail inspections.

Vision sensor advantages

Vision sensors provide fast pass/fail, yes/no, and go/no-go results to solve automated inspection challenges in ways which differ from other sensor types.



Identifies features photoelectric sensors cannot

Vision sensors locate and inspect highly patterned features that other sensors cannot.



Eliminates external triggers

Vision sensors overcome imprecise part positioning using patented multi-image analysis to determine whether a part is present.



Inspects multiple part features

A single vision sensor can perform multiple inspection types in a target image.



Works on a smart display or PC

Operators can set up new parameters or adjust existing inspections on a PC for easy interaction on the factory floor.



Optimizes illumination, brightness, and image contrast

Modular vision sensors can be outfitted with flexible lighting and filter options to create better images and achieve more consistent and reliable results.



Handles misalignment and variability

Vision sensors can detect objects regardless of their speed or position on the line--no mechanical fixturing required.



Easy to use

Simple development environments are designed for both new and existing users.

Vision sensors perform inspections first by locating the part in the image, then by looking for specific features on that part. Once the field of view (FOV) is set, an operator can run vision tools within the entire range of the target to inspect multiple features for their presence, completeness, or orientation—all in a single image. And even though data output is binary, data in aggregate can be used downstream to improve processes and perform diagnostics on a particular work cell. Unlike any other sensor, a vision sensor can handle misalignment and predictable variability in a work cell, so operators can use them in pre-configured cells without needing to make a number of costly and time-consuming changes. Whereas point source sensors must be perfectly aligned in order to function, vision sensors are designed to handle a high degree of variability. An object can therefore be inspected in any position on the belt.

Vision sensors solve advanced presence/absence detection by:

- Detecting a part by finding an actual part feature
- Inspecting features that other sensors cannot
- Inspecting multiple part features simultaneously
- Overcoming varying part positions on the line

Vision sensors generally require no programming, and provide easy guided set-up through user-friendly vision software interfaces. Most are easily integrated into larger systems to provide single- and multiple-point inspections with dedicated processing. Most offer built-in Ethernet communications, which enable users to exchange data with other systems to communicate results and trigger subsequent stages of an inspection. A network of vision sensors can be easily linked to plant and enterprise networks, allowing any workstation in the factory to view results, images, and data for process control. Depending on the specific system or application, vision software configures camera parameters, makes the pass/fail decision, communicates with the factory floor, and supports HMI development.

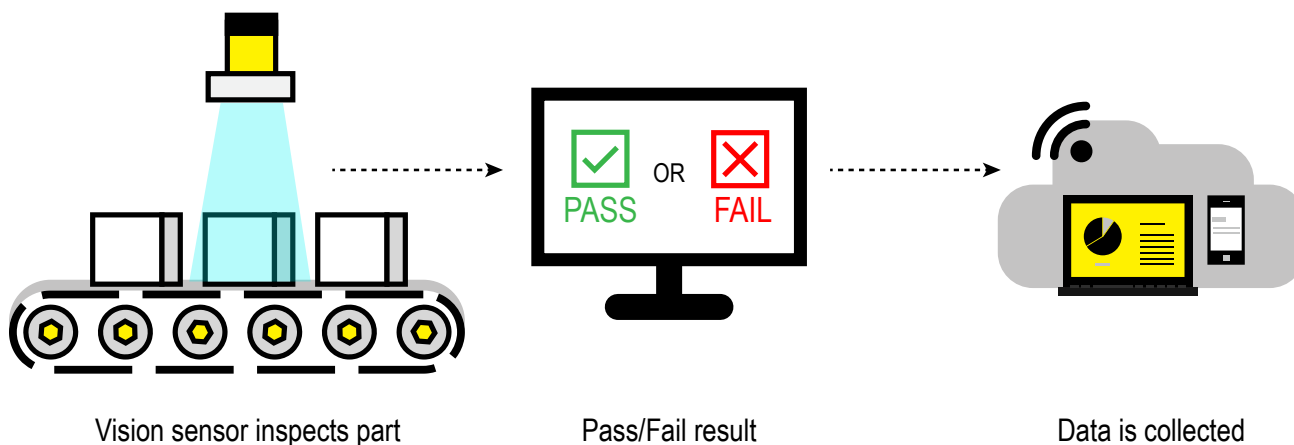







Figure 3. Vision sensors combine the power of a machine vision system with the simplicity and affordability of an industrial sensor, easily solving simple inspections and communicating results.

VISION SENSORS VS. VISION SYSTEMS

Selecting the right machine vision solution generally depends on the application's requirements, including development environment, capability, architecture, and cost. In some cases, vision sensors and machine vision systems may both be able to satisfy an operation's needs. Different models are designed to meet varying price and performance requirements.

Vision sensors are similar to machine vision systems in their powerful vision algorithms, self-contained and industrial-grade hardware, and high-speed image acquisition and processing. They are both designed to perform highly-detailed tasks on high-speed production lines. And while all perform inspections, they are engineered for different tasks. While machine vision systems perform guidance and alignment, optical character recognition, code reading, and gauging and metrology, vision sensors are purpose-built to determine the presence/absence of parts and generate simple pass/fail results. Vision sensors are also distinguished by their relative ease-of-use and quick deployment.

Vision sensors lack the most sophisticated vision tools available on standalone machine vision systems but can perform a great number of vision tasks in factory automation and logistics environments. Vision sensors are also more affordable than machine vision systems and require less expertise to run.

	Vision Sensors	2D Vision Systems
 Presence/Absence	✓	✓
 Inspection	✓	✓
 Guide/Align		✓
 OCR/OCV		✓
 Code Reading		✓
 Gauge/Measure		✓

VISION SENSOR COMPONENTS

Vision sensors share many common components with vision systems, including lighting, lenses, image sensors, controllers, vision tools, and communications protocols. Most machine vision hardware components, such as lighting modules, sensors, and processors are available commercially off-the-shelf (COTS). In many cases, they can also be purchased as an integrated system with all components in a single device.

Lighting: Illuminates the part being inspected, allowing its features to stand out so they can be clearly seen by camera.

Lens: Captures the image and presents it to the sensor in the form of light.

Image sensor: Converts light into a digital image which is then sent to the processor for analysis.

Vision Processing Tools: Processes and optimizes an image for analysis; reviews the image and extracts required information; uses algorithms to run the necessary inspection and make a related decision.

Communications: A discrete I/O signal or data sent over a serial connection to a device that is either logging information or using it.

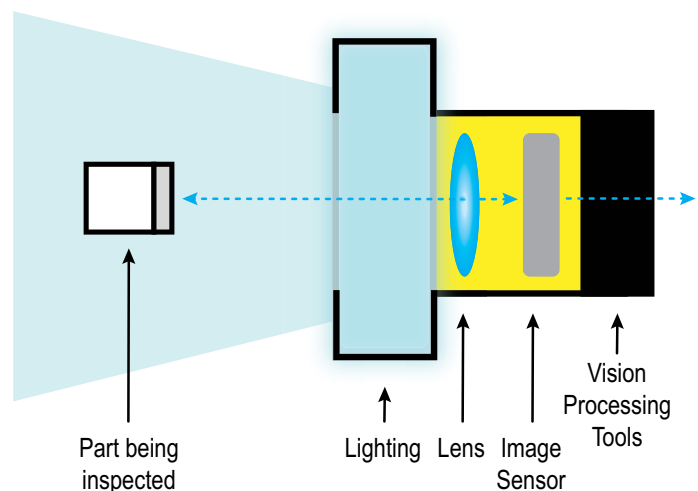

Figure 4. A sensor's compact, modular, powerful vision tools, and dedicated processing can be easily configured to solve a wide range of applications.

SOLVING APPLICATIONS WITH VISION SENSORS

Companies in a wide range of industries including heavy manufacturing, food and beverage, automotive, electronics, logistics, and transportation rely on vision sensors to perform simple pass/fail inspections that help ensure products and packaging are error-free and meet strict quality standards. By using vision sensors at key process points, defects can be caught earlier in the manufacturing process and equipment problems can be identified more quickly.

The first step in any sensor application is to locate, or fixture, the object or feature of interest within the camera's FOV. Pattern-matching and edge tools do this, detecting even challenging part features such as clear objects, printed text, and rough dimensions which photoelectric sensors cannot.

Once the sensor has a reference, it uses pattern, pixel count, brightness, contrast, and edge tools to perform an inspection. The data is compared to the inspection's specifications, tolerances, or thresholds to make a decision, which is communicated as a binary data output.

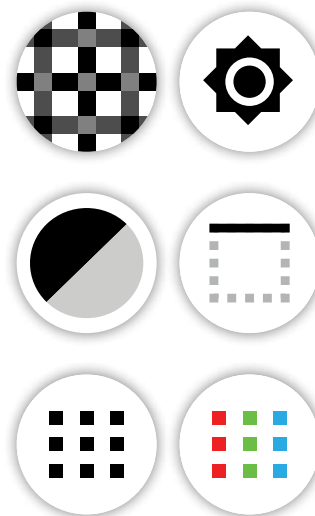

VISION TOOLS

Vision tools are what ultimately set machine vision sensors apart from other sensors. Vision technology plays a very important role for even the most basic presence/absence inspections. Typical vision tools include pattern, pixel count, brightness, contrast, and edge tools. Notably, a vision sensor can inspect multiple targets within a single image, as well as perform multiple inspection types relying on different tools.



Pattern Tool: Used to reference an inspection tool, as well as to perform inspection and counting. Performs best on patterns with sharp contrast and on targets small enough to allow variability and asymmetry in the FOV.

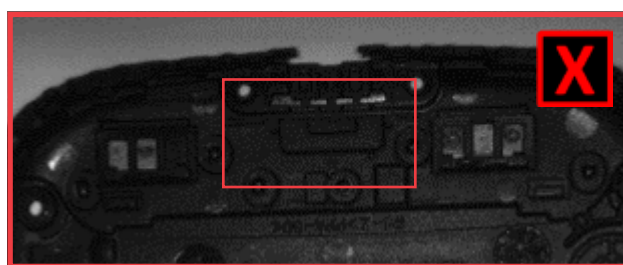
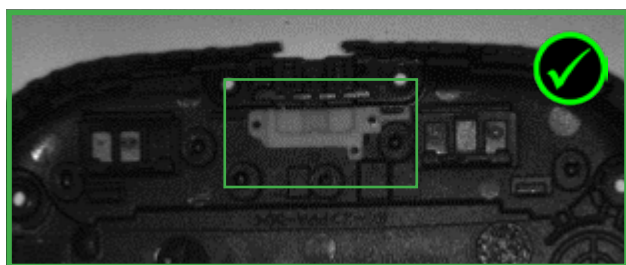

Pattern tool confirms that the gasket is present and installed in the correct area.



Brightness Tool: Returns the average pixel brightness for a region of interest. Illumination must be stable and predictable.

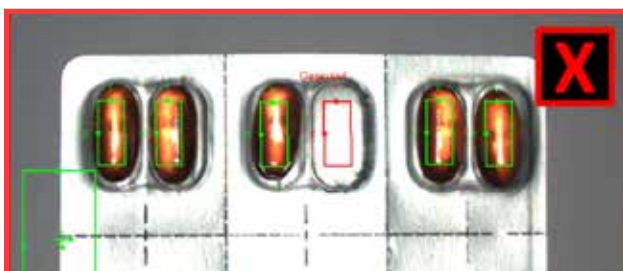
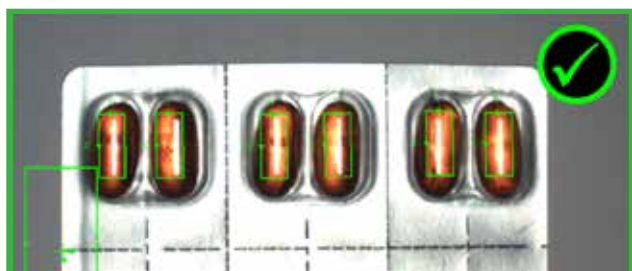

Brightness tool confirms the presence of all 10 capsules by showing the greatest delta between pass/fail areas.



Contrast Tool: Compares contrast across an entire region of interest. A useful tool if there are unpredictable changes in failed parts.

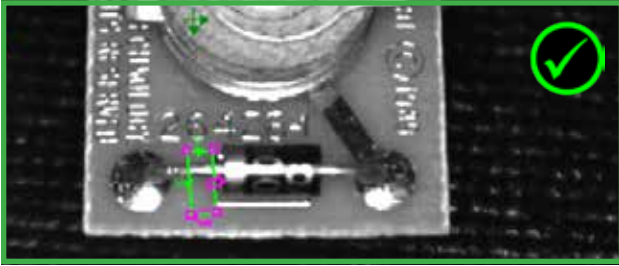

High contrast in the target area indicates the presence of a diode.



Edge tool: Inspects for a high contrast “edge” along a specific path. Can set thresholds to eliminate noise.

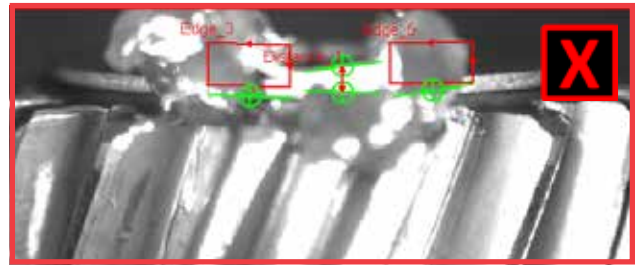
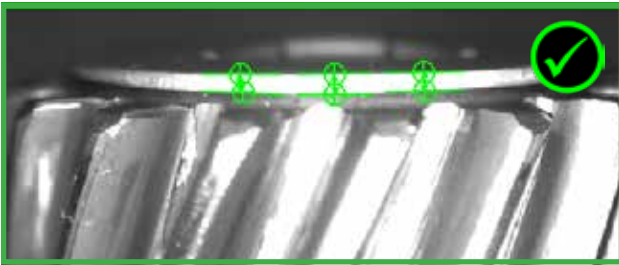

Multiple edge tools measure pixels to detect a clean edge on a drill burr.



Pixel count tool: Returns the total number of pixels between a set range. This works well for large FOV applications.

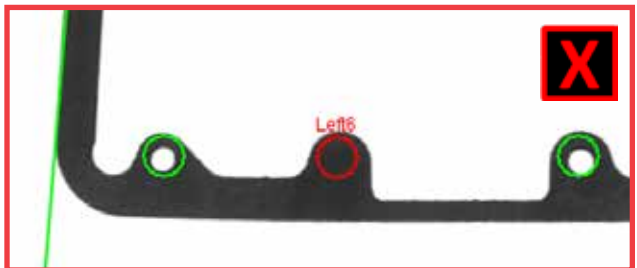
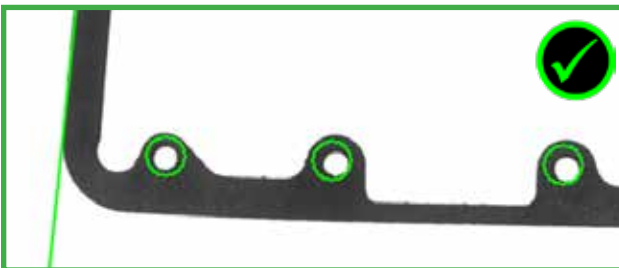

Pixel count tool confirms the presence of 13 separate hole punches within one target by determining pixel value.



Color Pixel Count: Returns a number of pixels within a specified region of interest that meet trained colors. This works best if illumination is applied evenly, since hotspots can cause problems.

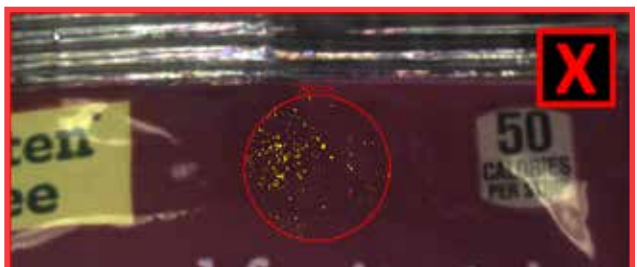

Color pixel count tool confirms the integrity of packaging by identifying pixel values of colors trained in the region of interest.

CHOOSING A VISION SENSOR SOLUTION

Technology and application requirements for automated inspections are constantly evolving. Development environment, lighting, and modularity are some of the most important features to consider when selecting a vision sensor.

Standardized Set-Up Environment

Even novice vision users should be able to easily set up, configure, and install a vision sensor. When selecting a vision sensor, consider not only current inspection needs but also future applications that may require more powerful and flexible vision systems. Fast processing and a reliable communications link to other factory automation equipment are essential.

Integrated Lighting

Factory environments and space constraints can make it difficult to achieve proper lighting conditions. This can be problematic for vision sensors, which rely on even, diffuse lighting to fixture parts and perform robust inspections with brightness, contrast, and pixel count tools. Vision sensors typically come with integrated lighting and can be connected to additional external lighting if required. Selecting a vision sensor with built-in lighting saves money on external illumination and mounting fixtures.

Flexible, Modular Design

It can be difficult to mount a vision sensor in the precise location to achieve optimal FOV, image resolution, and part illumination. Vision sensors with small form factors, which fit into any space and can be configured for in-line and right-angle mounting installation, help get inspections up and running quickly. Modular design simplifies optical paths and cable routing and allows users to change lights, optics, and lenses in the field for quick line changeovers or application modifications. Models with autofocus lenses eliminate the need to manually refocus or adjust mounting height.

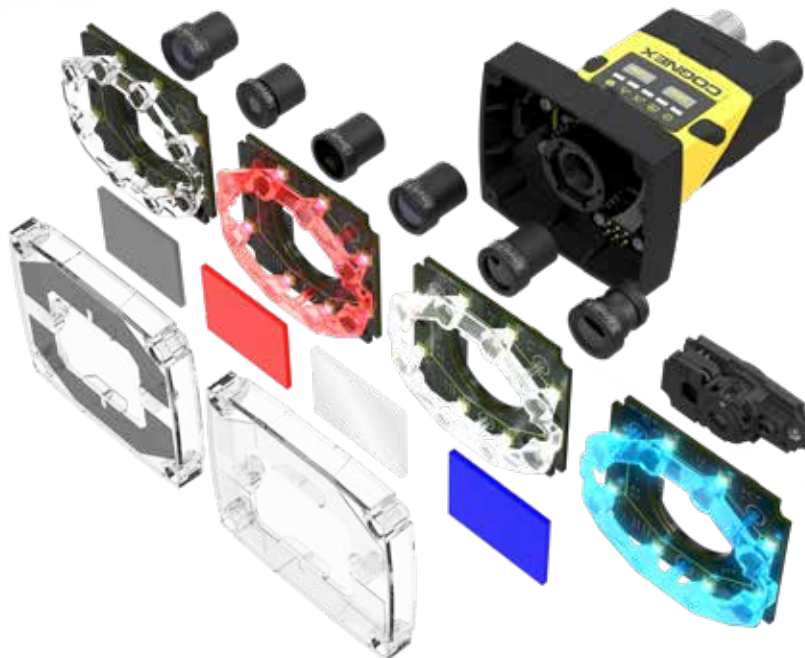

Figure 5. The In-Sight 2000 series offers a modular design with field changeable lights, lenses, filters, and covers. An integrated LED ring light produces even, diffuse illumination across the entire image, minimizing the need for costly external lighting.

CONCLUSION

Compared to the other types of sensors on the market, vision sensors greatly expand the types of simple inspections a manufacturer can perform and provide information beyond whether a part is simply present or absent. Vision sensors can inspect multiple elements per target, differentiate between colors, and respond well to misalignment and planned variability. By reducing defects and increasing yield, machine vision sensors can help manufacturers streamline their operations and increase profitability. With an array of vision tools and the possibility to perform multiple inspections per target, vision sensors can cut down on cycle time and improve product quality downstream.

THE COGNEX DIFFERENCE

Whatever your environment, resource constraints, and specific tool needs, Cognex sensors can help. At speeds up to 6,000 parts per minute, Cognex vision sensors set new standards for value, ease of use, and flexibility thanks to a powerful combination of proven Cognex In-Sight® vision tools, simple set-up, and a flexible, modular design. In-Sight 2000 series vision sensors are compact, configured for inline and right-angle mounting installation in tight spaces. Field-changeable, integrated optics and lighting adjust to changing application requirements and eliminate the cost of external lighting. The In-Sight Explorer EasyBuilder interface provides a fast, step-by-step application setup which allows even novice users to achieve extremely reliable inspection performance in nearly any production environment. In-Sight 2000 vision sensors are configured with In-Sight Explorer software—the world's most widely used environment for configuring and maintaining machine vision applications.

For more information about Cognex vision sensors, visit www.Cognex.com.

BUILD YOUR VISION

2D VISION SYSTEMS

Cognex machine vision systems are unmatched in their ability to inspect, identify, and guide parts. They are easy to deploy and provide reliable, repeatable performance for the most challenging applications.

- Industrial grade with a library of advanced vision tools
- High speed image acquisition and processing
- Exceptional application and integration flexibility

www.cognex.com/machine-vision



3D LASER PROFILERS

Cognex In-Sight laser profilers and 3D vision systems provide ultimate ease of use, power and flexibility to achieve reliable and accurate measurement results for the most challenging 3D applications.

- Factory calibrated sensors deliver fast scan rates
- Industry-leading vision software with powerful 2D and 3D tool sets
- Compact, IP65-rated design withstands harsh factory environments

www.cognex.com/3D-laser-profilers

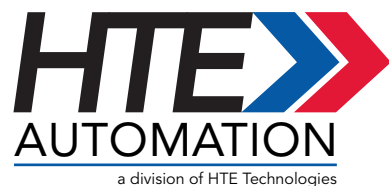
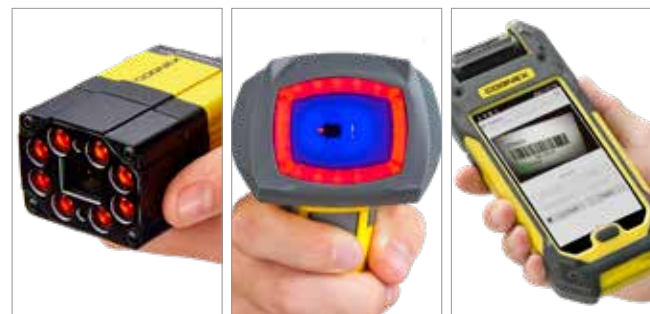

IMAGE-BASED BARCODE READERS

Cognex industrial barcode readers and mobile terminals with patented algorithms provide the highest read rates for 1-D, 2-D, and DPM codes regardless of the barcode symbology, size, quality, printing method, or surface.

- Reduce costs
- Increase throughput
- Control traceability

www.cognex.com/BarcodeReaders



ST. LOUIS

2021 Congressional Dr.
St. Louis, MO 63146
Tel: 314-731-4444

KANSAS CITY

8008 Reeder St.
Lenexa, KS 66214
Tel: 913-440-4477

SPRINGFIELD, MO

4319 S. National Ave.
Springfield, MO 65810
Tel: 417-724-2231

BLOOMINGTON, IL

1701 E. Empire St.
Bloomington, IL 61704
Tel: 217-615-4440

www.hteautomation.com

COGNEX

Companies around the world rely on Cognex vision and barcode reading to optimize quality, drive down costs, and control traceability.

Corporate Headquarters
One Vision Drive, Natick, MA 01760 USA
Tel: +1 855-426-4639

www.cognex.com